

Afmetingen configuraties BFM 30 / 50 / 80

Muurafvoer concentrisch

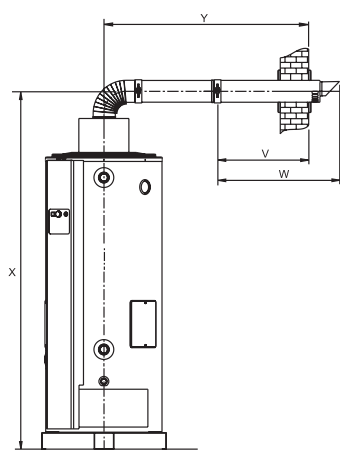

Muurafvoer concentrisch

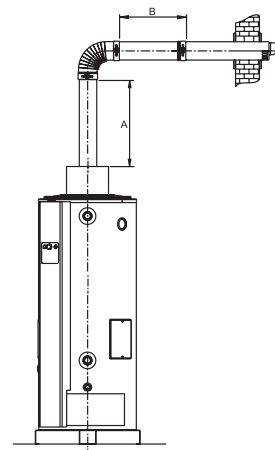

	BFM 30 Ø80/125	BFM 50 Ø100/150	BFM 80 Ø130/200
V	550	550	640
W	725	790	940
X	2115	2165	2190
Y	1195	1215	1310
Y*	745	765	860

	BFM 30		BFM 50		BFM 80	
	min.	max.	min.	max.	min.	max.
A	0	7000	0	7000	0	7000
B	0	7000	0	7000	0	7000
A+B	< 7000		< 7000		< 7000	
bochten	max. 2x45°/90°		max. 2x45°/90°		max. 2x45°/90°	

• Afmeting in mm

* Afmeting zonder concentrische buis tussen de bocht en muurdoorvoer

• Afmeting in mm

Dakafvoer concentrisch

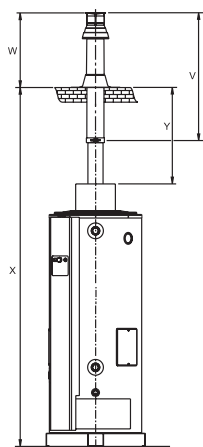

Dakafvoer concentrisch

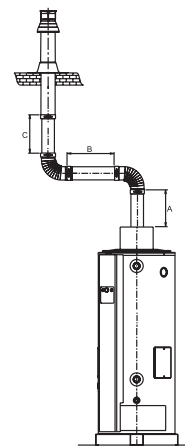

	BFM 30 Ø80/125	BFM 50 Ø100/150	BFM 80 Ø130/200
V	1230	1310	1610
W	605	645	1000
X	3575	3615	3580
Y	1575	1615	1560
Y**	625	665	610
Y**	625	465	465

	BFM 30		BFM 50		BFM 80	
	min.	max.	min.	max.	min.	max.
A	0	7000	0	7000	0	7000
B	0	7000	0	7000	0	7000
C	0	7000	0	7000	0	7000
A+B+C	< 7000		< 7000		< 7000	
bochten	max. 2x45°/90°		max. 2x45°/90°		max. 2x45°/90°	

• Afmeting in mm

** Afmeting zonder concentrische buis tussen de bocht en muurdoorvoer

• Afmeting in mm

Afmetingen configuraties BFM 100 / 120

Muurafvoer concentrisch

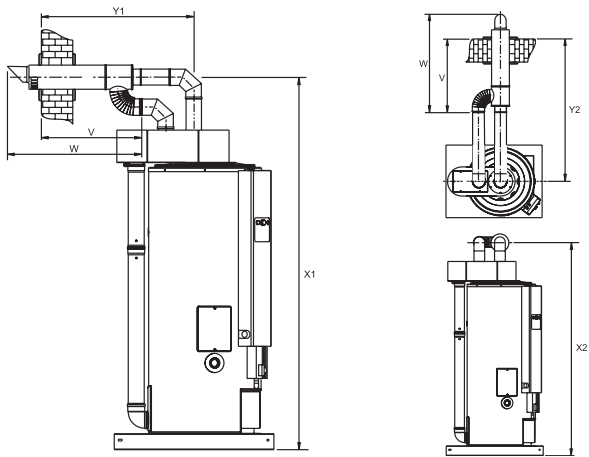

	BFM 100	BFM 120
	2 x Ø130	2 x Ø130
V	700	700
W	1000	1000
X1	2480	2480
Y1	955	955
X2	2140	2140
Y2	1320	1320
Y2 *	870	870

- Afmeting in mm
- * Afmeting zonder concentrische buis tussen de bocht en muurdoorvoer

Muurafvoer concentrisch

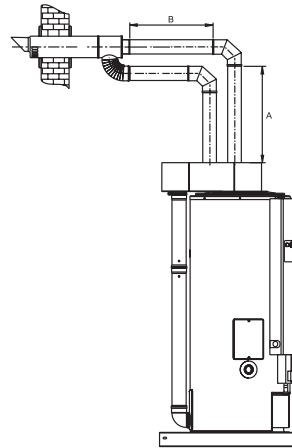

	BFM 100		BFM 120	
	min.	max.	min.	max.
A	0	7000	0	7000
B	0	7000	0	7000
A+B	< 7000		< 7000	
bochten	max. 2x45°/90°		max. 2x45°/90°	

- Afmeting in mm

Dakafvoer concentrisch

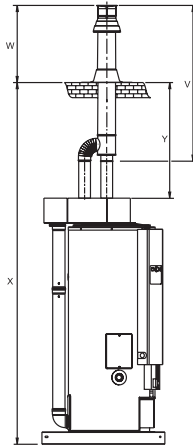

	BFM 100	BFM 120
	Ø130/200	Ø130/200
V	2560	2560
W	1000	1000
X	3580	3580
X **	2630	2630
Y	1560	1560
Y **	610	610

- Afmeting in mm
- ** Afmeting zonder concentrische buis tussen de bocht en muurdoorvoer

Dakafvoer concentrisch

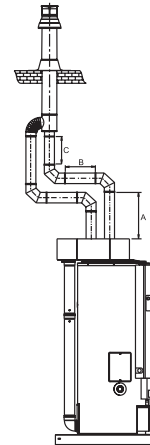

	BFM 100		BFM 120	
	min.	max.	min.	max.
A	0	7000	0	7000
B	0	7000	0	7000
C	0	7000	0	7000
A+B+C	< 7000		< 7000	
bochten	max. 2x45°/90°		max. 2x45°/90°	

- Afmeting in mm

Materiaal BFM categorie C13 incl. art. nrs.

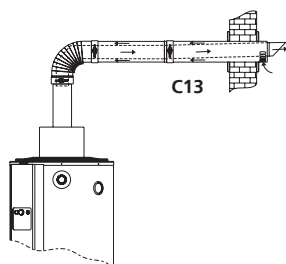

CATEGORIE C13					
Omschrijving	BFM 30 Ø80/125	BFM 50 Ø100/150	BFM 80 Ø130/200	BFM 100 2x Ø130	BFM 120 2x Ø130
Muurdoorvoerset	0302515	0302504	0311465	0306774	0306774
Muurdoorvoer *	0302516	0302505	0302313	0306803	0306803
Conc. bocht 45°	0302514	0311454	0311455	0311455	0311455
Conc. bocht 90°	0302513	0302502	0311456	0311456	0311456
Bocht 45°	0310197	0310197	0310197	0308026	0308026
Bocht 90°	0307164	0307164	0307164	0306805	0306805
Conc. pijp 500 mm	0302510	0302499	0302301	n.v.t.	n.v.t.
Conc. pijp 1000 mm	0311448	0311450	0311452	n.v.t.	n.v.t.
Conc. pijp 1500 mm	0311449	0311451	0311453	n.v.t.	n.v.t.
Pijp 500 mm	n.v.t.	n.v.t.	n.v.t.	0306804	0306804
Pijp 1000 mm	n.v.t.	n.v.t.	n.v.t.	0306802	0306802
Conc. pijp met meetnippel	0303853	0303854	0303855	n.v.t.	n.v.t.

* incl. 2 muurplaten en klemband.

Materiaal BFM categorie C33 incl. art. nrs.

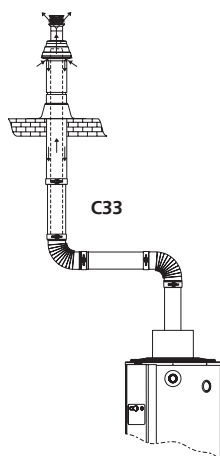

CATEGORIE C33					
Omschrijving	BFM 30 Ø80/125	BFM 50 Ø100/150	BFM 80 Ø130/200	BFM 100 2x Ø130	BFM 120 2x Ø130
Dakdoorvoerset	0311459	0311460	0311461	0306773	0306773
Dakdoorvoer	0302519	0302508	0302304	0306800	0306800
Plakplaat doorvoer	0302520	0302509	0302328	0302328	0302328
Conc. bocht 45°	0302514	0311454	0311455	n.v.t.	n.v.t.
Conc. bocht 90°	0302513	0302502	0311456	n.v.t.	n.v.t.
Bocht 45°	n.v.t.	n.v.t.	n.v.t.	0308026	0308026
Bocht 90°	n.v.t.	n.v.t.	n.v.t.	0306805	0306805
Conc. pijp 500 mm	0302510	0302499	0302301	n.v.t.	n.v.t.
Conc. pijp 1000 mm	0311448	0311450	0311452	n.v.t.	n.v.t.
Conc. pijp 1500 mm	0311449	0311451	0311453	n.v.t.	n.v.t.
Pijp 500 mm	n.v.t.	n.v.t.	n.v.t.	0306804	0306804
Pijp 1000 mm	n.v.t.	n.v.t.	n.v.t.	0306802	0306802
Conc. pijp met meetnippel	0303853	0303854	0303855	n.v.t.	n.v.t.

* incl. 2 muurplaten en klemband.

Overig rookgasafvoermateriaal BFM



DAKDOORVOERSET - CONCENTRISCH

Omschrijving	BFM 30	BFM 50	BFM 80	BFM 100	BFM 120
Ø80 / 125	0311459	-	-	-	-
Ø100 / 150	-	0311460	-	-	-
Ø130 / 200	-	-	0311461	-	-
Ø130 / 200	-	-	-	0306773*	0306773*

○ Inclusief plakplaat en concentrische pijp (1m)

* Bestaat uit een concentrische doorvoer, 2 x 1 m parallel verlengstuk, parallel naar concentrische adapter



DAKPAN VOOR CONC. DAKDOORVOER

Omschrijving	BFM 30	BFM 50	BFM 80	BFM 100	BFM 120
Ø80 / 125 Hoek 25°-45°	0303506	-	-	-	-
Ø100 / 150 Hoek 25°-45°	-	0306017	-	-	-



PIJP - CONCENTRISCH

Omschrijving	BFM 30	BFM 50	BFM 80
Ø80 / 125 L = 500 mm	0302510	-	-
Ø80 / 125 L = 1000 mm	0311448	-	-
Ø80 / 125 L = 1500 mm	0311449	-	-
Ø100 / 150 L = 500 mm	-	0302499	-
Ø100 / 150 L = 1000 mm	-	0311450	-
Ø100 / 150 L = 1500 mm	-	0311451	-
Ø130 / 200 L = 500 mm	-	-	0302301
Ø130 / 200 L = 1000 mm	-	-	0311452
Ø130 / 200 L = 1500 mm	-	-	0311453

○ Inkortbaar

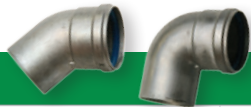

BOCHT - PARALLEL

Omschrijving	BFM 30	BFM 50	BFM 80	BFM 100	BFM 120
Ø100 Hoek 45°	0310197	0310197	0310197	-	-
Ø100 Hoek 87/90°	0307164	0307164	0307164	-	-
Ø130 Hoek 87/90°	-	-	-	0306805	0306805
Ø130 Hoek 45°	-	-	-	0308026	0308026



T-STUK - CONCENTRISCH

Omschrijving	BFM 30	BFM 50	BFM 80	BFM 100	BFM 120
Ø80 / 125	0307487	-	-	-	-
Ø100 / 150	-	0305244	-	-	-
Ø130 / 200	-	-	0307488	-	-



KLEMBAND - PIJP MET PIJP

Omschrijving	BFM 30	BFM 50	BFM 80	BFM 100	BFM 120
Ø125	0302517(S)	-	-	-	-
Ø150	-	0302506(S)	-	-	-
Ø200	-	-	0302305(S)	0302305(S)	0302305(S)



PLAKPLAAT - CONC. DAKDOORVOER

Omschrijving	BFM 30	BFM 50	BFM 80	BFM 100	BFM 120
Doorvoer	Plaat				
Ø80 / 125	Ø140	0302520	-	-	-
Ø100 / 150	Ø170	-	0302509	-	-
Ø130 / 200	Ø210	-	-	0302328	0302328

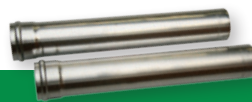

PIJP - PARALLEL

Omschrijving	BFM 30	BFM 50	BFM 80	BFM 100	BFM 120
Ø130 L = 500 mm	-	-	-	0306804	0306804
Ø130 L = 1000 mm	-	-	-	0306802	0306802

○ Set van 2 stuks



MUURDOORVOERSET - CONCENTRISCH

Omschrijving	BFM 30	BFM 50	BFM 80	BFM 100	BFM 120
Ø80 / 125	0302515	-	-	-	-
Ø100 / 150	-	0302504	-	-	-
Ø130 / 200	-	-	0311465	-	-
Ø130 / 200	-	-	-	0306774	0306774

○ Inclusief concentrische pijp (0,5m), bocht (90°) en muurplaten



BOCHT - CONCENTRISCH

Omschrijving	BFM 30	BFM 50	BFM 80	BFM 100	BFM 120
Ø80 / 125 Hoek 90°	0302513	-	-	-	-
Ø80 / 125 Hoek 45°	0302514	-	-	-	-
Ø100 / 150 Hoek 90°	-	0302502	-	-	-
Ø100 / 150 Hoek 45°	-	0311454	-	-	-
Ø130 / 200 Hoek 90°	-	-	0311456	-	-
Ø130 / 200 Hoek 45°	-	-	0311455	-	-



ADAPTER - CONC. NAAR PAR.

Omschrijving	BFM 30	BFM 50	BFM 80	BFM 100	BFM 120
van	naar				
Ø130 / 200	1 x Ø225	-	-	0306801	0306801



MEETSTUK - CONCENTRISCH

Omschrijving	BFM 30	BFM 50	BFM 80
Ø80 / 125	0303853	-	-
Ø100 / 150	-	0303854	-
Ø130 / 200	-	-	0303855