

Dimensions configurations BFM 30 / 50 / 80

Wall duct concentric

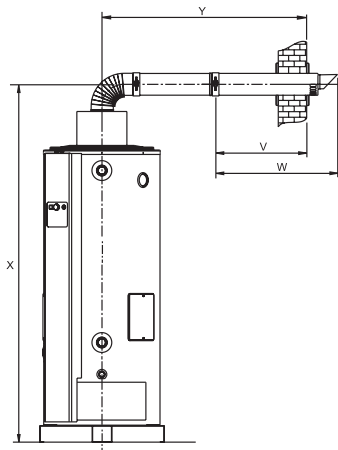

	BFM 30 Ø80/125	BFM 50 Ø100/150	BFM 80 Ø130/200
V	550	550	640
W	725	790	940
X	2115	2165	2190
Y	1195	1215	1310
Y*	745	765	860

• Dimensions in mm

* Dimensions without concentric tube between the bend and the wall duct

Wall duct concentric

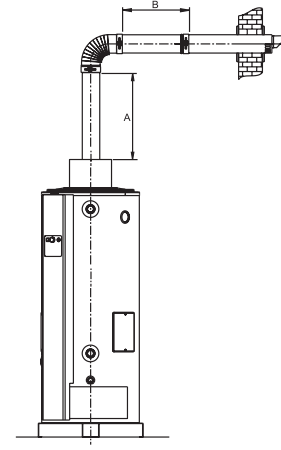

	BFM 30		BFM 50		BFM 80	
	min.	max.	min.	max.	min.	max.
A	0	7000	0	7000	0	7000
B	0	7000	0	7000	0	7000
A+B	< 7000		< 7000		< 7000	
bends	max. 2x45°/90°		max. 2x45°/90°		max. 2x45°/90°	

• Dimensions in mm

Roof duct concentric

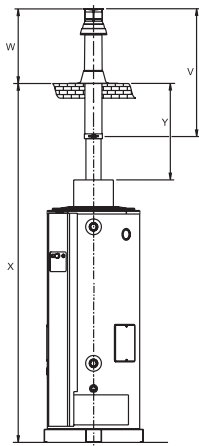

	BFM 30 Ø80/125	BFM 50 Ø100/150	BFM 80 Ø130/200
V	1230	1310	1610
W	605	645	1000
X	3575	3615	3580
Y	1575	1615	1560
Y**	625	665	610
Y**	625	465	465

• Dimensions in mm

** Dimensions without concentric tube between the bend and the wall duct

Roof duct concentric

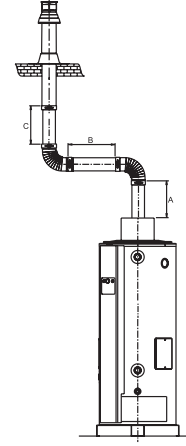

	BFM 30		BFM 50		BFM 80	
	min.	max.	min.	max.	min.	max.
A	0	7000	0	7000	0	7000
B	0	7000	0	7000	0	7000
C	0	7000	0	7000	0	7000
A+B+C	< 7000		< 7000		< 7000	
bends	max. 2x45°/90°		max. 2x45°/90°		max. 2x45°/90°	

• Dimensions in mm

Dimensions configurations BFM 100 / 120

Wall duct concentric

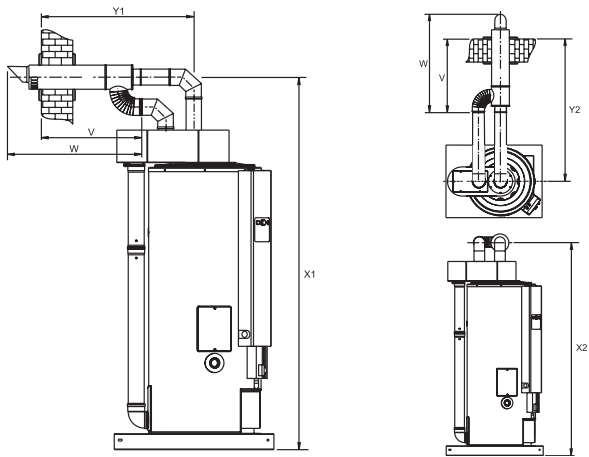

	BFM 100	BFM 120
	2 x Ø130	2 x Ø130
V	700	700
W	1000	1000
X1	2480	2480
Y1	955	955
X2	2140	2140
Y2	1320	1320
Y2 *	870	870

- Dimensions in mm
- * Dimensions without concentric tube between the bend and the wall duct

Wall duct concentric

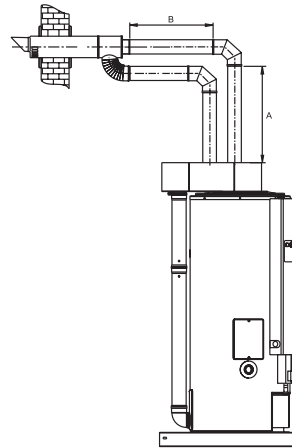

	BFM 100		BFM 120	
	min.	max.	min.	max.
A	0	7000	0	7000
B	0	7000	0	7000
A+B	< 7000		< 7000	
bends	max. 2x45°/90°		max. 2x45°/90°	

- Dimensions in mm

Roof duct concentric

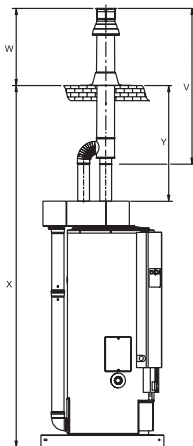

	BFM 100	BFM 120
	Ø130/200	Ø130/200
V	2560	2560
W	1000	1000
X	3580	3580
X **	2630	2630
Y	1560	1560
Y **	610	610

- Dimensions in mm
- ** Dimensions without concentric tube between the bend and the wall duct

Roof duct concentric

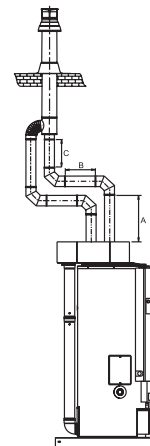

	BFM 100		BFM 120	
	min.	max.	min.	max.
A	0	7000	0	7000
B	0	7000	0	7000
C	0	7000	0	7000
A+B+C	< 7000		< 7000	
bends	max. 2x45°/90°		max. 2x45°/90°	

- Dimensions in mm

Materials BFM category C13 incl. art.no.

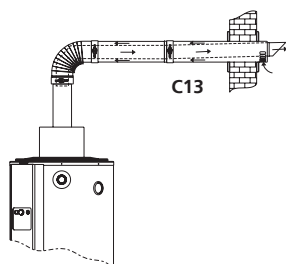

CATEGORY C13					
Description	BFM 30 Ø80/125	BFM 50 Ø100/150	BFM 80 Ø130/200	BFM 100 2x Ø130	BFM 120 2x Ø130
Wall flue terminal	0302515	0302504	0311465	0306774	0306774
Wall flue terminal set*	0302516	0302505	0302313	0306803	0306803
Conc. bend 45°	0302514	0311454	0311455	0311455	0311455
Conc. bend 90°	0302513	0302502	0311456	0311456	0311456
Bend 45°	0310197	0310197	0310197	0308026	0308026
Bend 90°	0307164	0307164	0307164	0306805	0306805
Conc. tube 500 mm	0302510	0302499	0302301	N/A	N/A
Conc. tube 1000 mm	0311448	0311450	0311452	N/A	N/A
Conc. tube 1500 mm	0311449	0311451	0311453	N/A	N/A
Tube 500 mm	N/A	N/A	N/A	0306804	0306804
Tube 1000 mm	N/A	N/A	N/A	0306802	0306802
Measurement unit	0303853	0303854	0303855	N/A	N/A

* incl. 2 wall flanges and clamping strip.

Materials BFM category C33 incl. art.no.

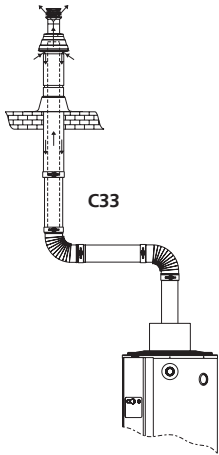

CATEGORY C33					
Description	BFM 30 Ø80/125	BFM 50 Ø100/150	BFM 80 Ø130/200	BFM 100 2x Ø130	BFM 120 2x Ø130
Roof flue terminal set*	0311459	0311460	0311461	0306773	0306773
Roof flue terminal	0302519	0302508	0302304	0306800	0306800
Flange roof terminal	0302520	0302509	0302328	0302328	0302328
Conc. bend 45°	0302514	0311454	0311455	N/A	N/A
Conc. bend 90°	0302513	0302502	0311456	N/A	N/A
Bend 45°	N/A	N/A	N/A	0308026	0308026
Bend 90°	N/A	N/A	N/A	0306805	0306805
Conc. tube 500 mm	0302510	0302499	0302301	N/A	N/A
Conc. tube 1000 mm	0311448	0311450	0311452	N/A	N/A
Conc. tube 1500 mm	0311449	0311451	0311453	N/A	N/A
Tube 500 mm	N/A	N/A	N/A	0306804	0306804
Tube 1000 mm	N/A	N/A	N/A	0306802	0306802
Measurement unit	0303853	0303854	0303855	N/A	N/A

* incl. 2 wall flanges and clamping strip.

Additional flue gas discharge material BFM



ROOF FLUE TERMINAL SET - CONCENTRIC (AL)

Description	BFM 30	BFM 50	BFM 80	BFM 100	BFM 120
Ø 80 / 125	0311459	-	-	-	-
Ø 100 / 150	-	0311460	-	-	-
Ø 130 / 200	-	-	0311461	-	-
Ø 130 / 200	-	-	-	0306773*	0306773*

○ Incl. flange and concentric tube (1m)

*0306773 contains: a concentric terminal, 2 x 1m parallel extensions, parallel to concentric adapter

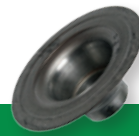

FLANGE - CONC. ROOF TERMINAL (AL)

Description		BFM 30	BFM 50	BFM 80	BFM 100	BFM 120
Terminal	Flange					
Ø 80 / 125	Ø 140	0302520	-	-	-	-
Ø 100 / 150	Ø 170	-	0302509	-	-	-
Ø 130 / 200	Ø 210	-	-	0302328	0302328	0302328

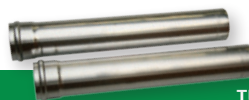

TUBE - PARALLEL (AL)

Description		BFM 30	BFM 50	BFM 80	BFM 100	BFM 120
Ø 130	L = 500 mm	-	-	-	0306804	0306804
Ø 130	L = 1000 mm	-	-	-	0306802	0306802

○ Set of 2 pieces



TUBE - CONCENTRIC (AL)

Description		BFM 30	BFM 50	BFM 80
Ø 80 / 125	L = 500 mm	0302510	-	-
Ø 80 / 125	L = 1000 mm	0311448	-	-
Ø 80 / 125	L = 1500 mm	0311449	-	-
Ø 100 / 150	L = 500 mm	-	0302499	-
Ø 100 / 150	L = 1000 mm	-	0311450	-
Ø 100 / 150	L = 1500 mm	-	0311451	-
Ø 130 / 200	L = 500 mm	-	-	0302301
Ø 130 / 200	L = 1000 mm	-	-	0311452
Ø 130 / 200	L = 1500 mm	-	-	0311453

○ Cuttable



WALL FLUE TERMINAL SET - CONCENTRIC (AL)

Description		BFM 30	BFM 50	BFM 80	BFM 100	BFM 120
Ø 80 / 125		0302515	-	-	-	-
Ø 100 / 150		-	0302504	-	-	-
Ø 130 / 200		-	-	0311465	-	-
Ø 130 / 200		-	-	-	0306774	0306774

○ Incl. concentric tube (0.5m), bend (90°) and wall flanges

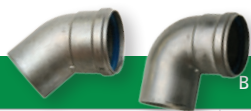

BEND - PARALLEL (AL)

Description		BFM 30	BFM 50	BFM 80	BFM 100	BFM 120
Ø 100	Angle 45°	0310197	0310197	0310197	-	-
Ø 100	Angle 87/90°	0307164	0307164	0307164	-	-
Ø 130	Angle 87/90°	-	-	-	0306805	0306805
Ø 130	Angle 45°	-	-	-	0308026	0308026



BEND - CONCENTRIC (AL)

Description		BFM 30	BFM 50	BFM 80	BFM 100	BFM 120
Ø 80 / 125	Angle 90°	0302513	-	-	-	-
Ø 80 / 125	Angle 45°	0302514	-	-	-	-
Ø 100 / 150	Angle 90°	-	0302502	-	-	-
Ø 100 / 150	Angle 45°	-	0311454	-	-	-
Ø 130 / 200	Angle 90°	-	-	0311456	-	-
Ø 130 / 200	Angle 45°	-	-	0311455	-	-



T-TUBE - CONCENTRIC (AL)

Description	BFM 30	BFM 50	BFM 80	BFM 100	BFM 120
Ø 80 / 125	0307487	-	-	-	-
Ø 100 / 150	-	0305244	-	-	-
Ø 130 / 200	-	-	0307488	-	-



ADAPTER - CONC. TO PAR. (AL)

Description		BFM 30	BFM 50	BFM 80	BFM 100	BFM 120
from	to					
Ø 130 / 200	1 x Ø 225	-	-	-	0306801	0306801



CLAMPING STRIP - TUBE WITH TUBE (AL)

Description	BFM 30	BFM 50	BFM 80	BFM 100	BFM 120
Ø 125	0302517(S)	-	-	-	-
Ø 150	-	0302506	-	-	-
Ø 200	-	-	0302305	0302305	0302305



MEASUREMENT UNIT - CONCENTRIC (AL)

Description	BFM 30	BFM 50	BFM 80
Ø 80 / 125	0303853	-	-
Ø 100 / 150	-	0303854	-
Ø 130 / 200	-	-	0303855